

## Calif dmv driving manual

---

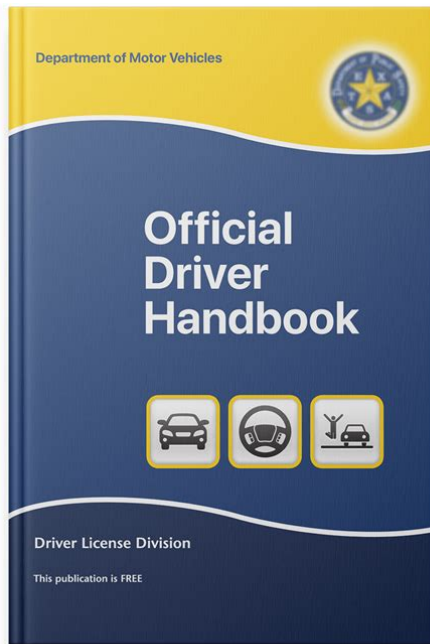

**File Name:** Calif dmv driving manual.pdf

**Size:** 3071 KB

**Type:** PDF, ePub, eBook

**Category:** Book

**Uploaded:** 22 May 2019, 15:27 PM

**Rating:** 4.6/5 from 834 votes.

**Download Now!**

Please check the box below to proceed.



I'm not a robot



reCAPTCHA  
Privacy - Terms

## Book Descriptions:

# Calif dmv driving manual

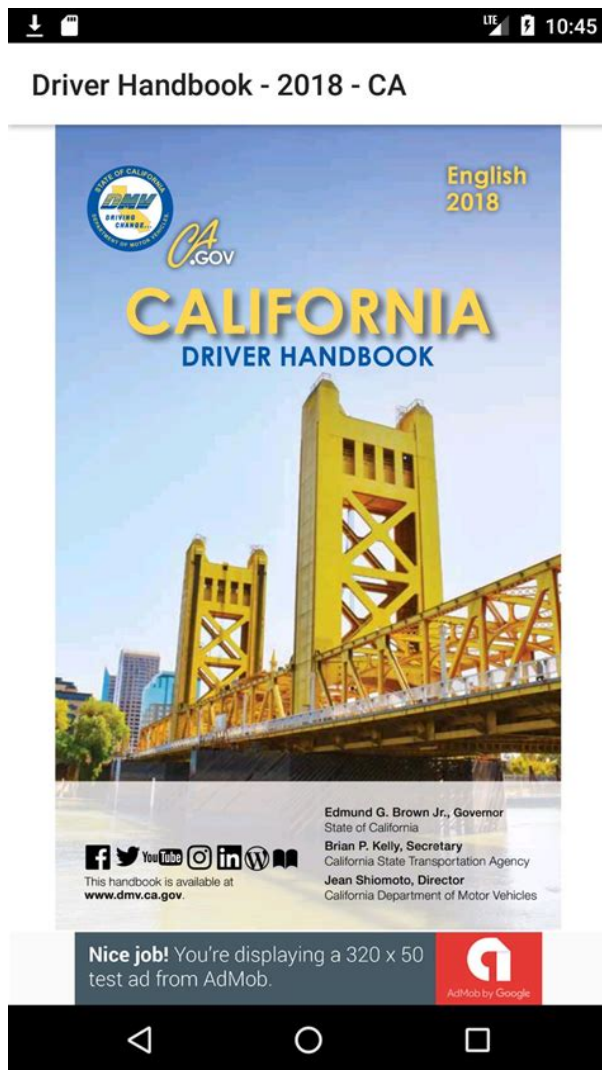

Traveling twenty miles in California can change everything around you, from the scenery to the weather, but it's easier to do that traveling when you can drive, and that driving starts with studying the California Driver's Handbook. California has the secondlargest amount of roads in the entire United States, so being able to drive is often a rite of passage in many cities and necessary to get around. On this page, you'll find the latest version of the state handbook, pulled directly from the California DMV, which you can easily read, browse, and search using the controls on the page. Once you've reviewed the handbook enough to get comfortable, you can start taking our California permit practice tests, and you'll be getting your permit before you know it. How would you rate your driving. Expert level Beginner level Needs improvement Take a free CA DMV quiz The DMV handbook alone isnt enough. If you only study the official manual, your probability of passing the DMV Exam is 49%. You can double your chances with our Premium program. Got it Show me how Follow us on DrivingTests.org is a privately owned website that is not affiliated with or operated by any state government agency. California Motorcycle Handbook. California CDL Handbook. Manual de Manejo de California. Manual de Manejo de Motocicleta de California. Manual de Licencia Comercial de California The number of people who opt into taking the permit test without opening the drivers manual even once is simply mindboggling. Dont make the same mistake, read the DMV drivers handbook and nail the permit test the first time you take it!You can probably skip the first

chapter that covers license requirements, the testing process, miscellaneous license information and the special section for minors if it does not apply to you, but be sure to check out cell phone restrictions for minors even if you are an adult the DMV expects you to know them regardless of your age. <http://www.jemdove.com.au/userfile/file/digidesign-stage-rack-manual.xml>

- **california dmv driving manual, california dmv driving manual pdf, california dmv driving manual chinese, california dmv driver s manual, california dmv driver s manual 2020, california dmv driver s manual 2019, california dmv driver s manual download, california dmv driving handbook, california dmv driving handbook chinese, california dmv driving test manual, 1.0.**

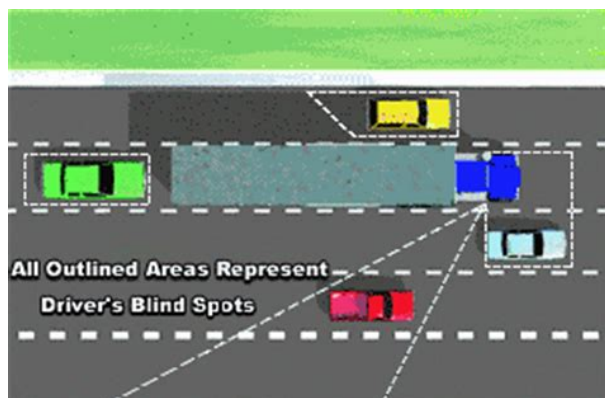

California DMV permit test questions cover pretty much everything between pages 17 and 87. Yes, all those 70 pages. It may seem like a touch too much, but it really isn't. Plenty of the space in the 2020 California drivers manual is taken up by illustrations of various onroad situations, images that take up entire pages, there's even a California drivers handbook practice test at the end of almost every chapter, so it's not like you will be reading 70 pages of fine print. Besides, who said you have to read the entire DMV book in one day. In fact, we recommend that you start preparing for your drivers permit test at least two weeks in advance. If you do this, you won't have to read more than 5 pages a day anyone can do that! We have prepared a California DMV practice test you can take online right now. In fact, we've got an entire batch of practice permit tests with multiple choice questions tailored to the 2020 DMV written test and they are all free. Head over to the practice test section and play with them as soon as you're done with the drivers handbook, we dare you to complete each and every one of them! This way you won't have to download the book every time you feel like studying and you can cross reference any permit test question you have doubts about against the manual. All rights reserved. Sale Ends 00 Hours Drivers Ed Texas Parent Taught Drivers Ed Texas Adult Drivers Ed Texas Instructor Taught Drivers Ed California Drivers Ed Florida Drivers Ed Georgia Drivers Ed Ohio Teen Drivers Ed Pennsylvania Teen Drivers Ed Driving Lessons Browse All Drivers Ed Courses Defensive Driving California Traffic School Texas Defensive Driving Florida Basic Driver Improvement Indiana Defensive Driving Browse All Defensive Driving Courses Help Center About Blog Careers Partnerships Roadside Assistance Aceable Real Estate School Sign In Menu The California Driver Handbook Wondering how to change the gender on your drivers license in California. <http://www.derma-dts.de/files/digidesign-profile-user-manual.xml>

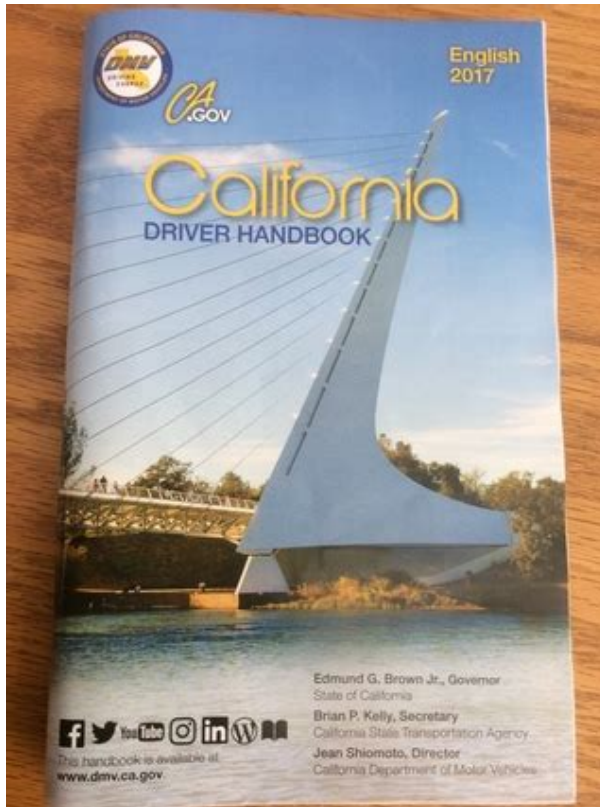

Check out our stepbystep guide with everything you need to know. Just kidding it's actually pretty simple and straightforward, and it begins with getting your learner permit. But in order to do that, you'll have to pass the driver test first. Looking for more resources. Study the California Driver Handbook, which is where all the questions for the test will come from. The best part You can get the manual for free we'll link to all the places where you can get the handbook at the end of the post. Includes free study guide.It's available for all types of drivers including commercial and motorcycle in a wide variety of languages English, Armenian, Spanish, Chinese, Korean, Vietnamese, Tagalog, Russian, Punjabi, Farsi, American Sign Language. All of this will help you drive safely and successfully in the state of California! These laws include Use of Electronic Wireless Devices, DUI Ignition Interlock Device, Motorcycle Lane Splitting, and Public Transit Bus Lanes. As well the California DMV office general phone numbers. Generally, California Residents, California Resident Military Personnel, and New California Residents must have a driver license in California. As well as what qualifies as cheating during the examination. In addition it includes the exception to these requirements such as medical necessity, schooling or schoolauthorized activity, employment necessity, and necessity to drive an immediate family member. This includes how to change your name on your license, how to renew your driver license, and how to extend your driver license. The app also offers sample quizzes, instructional videos, and interactive tutorials. Download a PDF of the CDL handbook on the DMV website here. All rights reserved. You can get a free copy here and well even help answer your questions.

This trusty state document has all of the information you need including licensing requirements, the laws and rules for driving in the State of California, and what to do during emergency situations. The handbook has the rules and steps of safe driving, but cant set you up with skills that you need to be fully prepared behind the wheel. With our DMVapproved, fully online course, you choose when and where you want to study. Its a large document so dont expect to finish it in a day. The best approach is to read through the entire thing, cover to cover, in about a week or so. No need to take notes or memorize the materials just yet. On the second or third read, go more slowly with a stronger focus on remembering key sections and rules. This will help cement the foundation youll need to succeed in the course. Itll still be a great idea to keep a recent copy of the California Drivers Handbook in your car, just in case you need to refer to it in times of need. For a printed copy, just head to your

local DMV office. Please try again. Please try again. In order to navigate out of this carousel please use your heading shortcut key to navigate to the next or previous heading. Drivers' Handbook Page 1 of 1 Start over Page 1 of 1 In order to navigate out of this carousel please use your heading shortcut key to navigate to the next or previous heading. Register a free business account Please try your search again later. Your Order Also Includes A Free California DMV Drivers Handbook 2020. You will receive all of the correct questions and answers to the test and a complimentary copy of the drivers handbook. These are the latest 2020 questions and answers to the official DMV tests. The 2020 edition is the latest printed handbook available. This drivers handbook along with the questions and answers to the test are all up to date. All study materials received will always be current and up to date. Please note that item is not eligible for shipping to any Correctional Facilities.

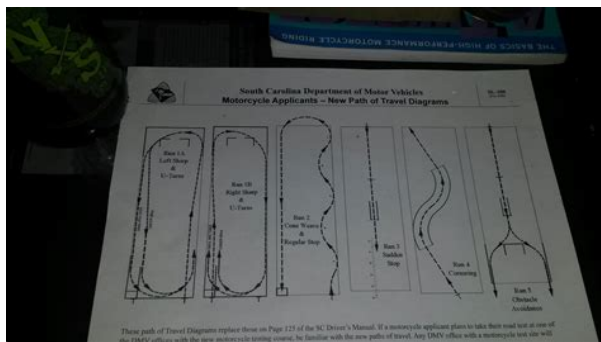

<https://www.thebiketube.com/acros-3m-mp8610-service-manual>

Disclaimer We are not affiliated with the DMV. To calculate the overall star rating and percentage breakdown by star, we don't use a simple average. Instead, our system considers things like how recent a review is and if the reviewer bought the item on Amazon. It also analyzes reviews to verify trustworthiness. Please try again later. E. Palacin 5.0 out of 5 stars Its been 40 years since i had to do the written test, so i read this book. It helped me to remember some of the rules. Study it, take your test, and simply pass! Passed on my first try 100% happy!! Better print the online pdf. The handbook was up to date, easy to read and the practice tests were very helpful. Passed the test with flying colors! Please try again. Please try again. Disclaimer We are not affiliated with the DMV. In order to navigate out of this carousel please use your heading shortcut key to navigate to the next or previous heading. Drivers' Handbook Page 1 of 1 Start over Page 1 of 1 In order to navigate out of this carousel please use your heading shortcut key to navigate to the next or previous heading. Register a free business account Please try your search again later. To calculate the overall star rating and percentage breakdown by star, we don't use a simple average. Instead, our system considers things like how recent a review is and if the reviewer bought the item on Amazon. It also analyzes reviews to verify trustworthiness. Directions Before taking the CA sample DMV test, study the driver handbook which covers all the necessary information on the DMV driving test answers and questions are included. Each question has three answer choices. Choose one answer and mark an X in the box across from the answer. Here are the main CA DMV requirements for passing the driving test Do not talk while taking the DMV drive test; do not use any books or notes, or cell phone, or electronic devices, or leave the test area before your test has been graded.

<http://www.compass-it.com/images/breville-ultimate-bakers-oven-manual.pdf>

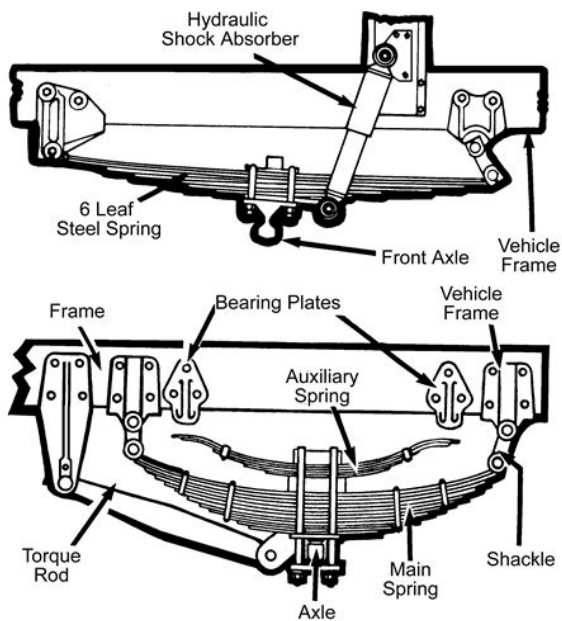
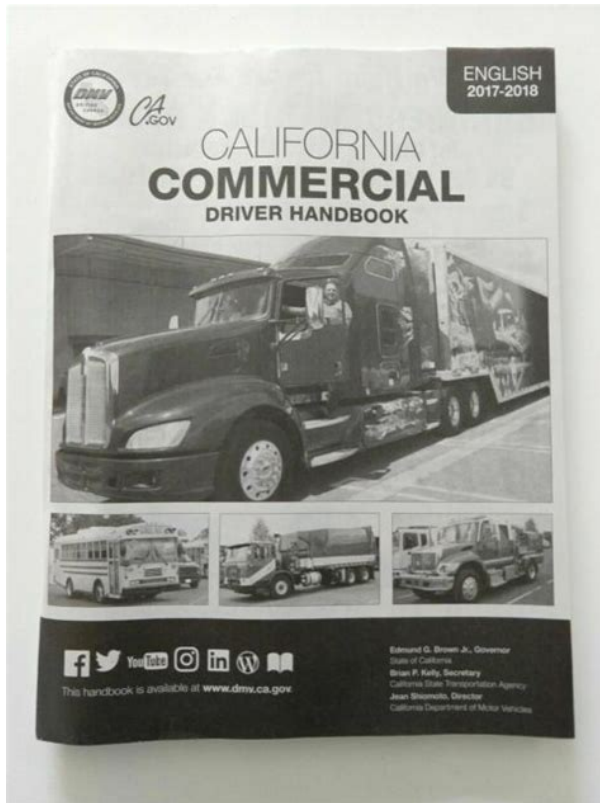

Figure 2-2

It may result in a test failure and you may be suspended or revoked. Motorists must enter from the right, yielding to traffic already in the roundabout, and follow the circle to the right until the desired roadway is reached. more Overthecounter medicines that you take for colds and allergies can make you drowsy and affect your driving ability. It is your responsibility to know how your medication affects your ability to drive. more Merge into the gap when it is safe to do so. Be alert to other traffic and do not expect other drivers to clear the lane. more Which direction do you turn your front wheels Dashed yellow lines alongside solid yellow lines indicate that passing is permitted from the lane next to the broken line, but not from the lane next to the solid line. Only change lanes when it is safe to do so. more This sign warns that your current road ends at an intersection straight ahead. Slow down and prepare to yield or stop before turning right or left. more You may never turn left or right when stopped by a traffic light with a red arrow. more. Using this study guide and taking the permit practice test will help to ease the process. To study for your written permit test, it is important to thoroughly read the California DMV Driver Handbook. All the information on the test is covered in the handbook. Read it carefully and reread any section about which you are not completely clear. However you may want to pay special attention to the Law and Rules of the Road section, as well as the Safe Driving Practices section, since a large proportion of the questions tend to come from those sections. The test is quite similar to the one that you will take to get your driver's license, but also includes questions about permit restrictions and requirements for new drivers. Study the Special Section on Minors in the handbook for details.

<http://completedetailspainting.com/images/breville-urn-manual.pdf>



Other sections commonly covered on the test to pay special attention to while studying include This is the official California permit drivers manual from the DMV! Take a look at our other California Permit Resources! California Permit Practice Test All company, product and service names used in this website are for identification purposes only. Use of these names, logos, and brands does not imply endorsement. Dmv Test Manual California Youtube Youtubers YouTube Enjoy the videos and music you love, upload original content, and share it all with friends, family, and the world on YouTube. Dmv Test Manual California Youtube Youtubers YouTube Enjoy the videos and music you love, upload original content, and share it all with friends, family, and the world on YouTube. Your Turn Manual California Youtube Youtubers YouTube Enjoy the videos and music you love, upload original content, and share it all with friends, family, and the world on YouTube. Sign Meaning Run Out First Game Green Arrow Android Running Feelings Arcade Health YouTube Enjoy the videos and music you love, upload original content, and share it all with friends, family, and the world on YouTube. Yellow Sign Sign Meaning Signs Youtube Manual California Novelty Signs Sign Youtubers YouTube Enjoy the videos and music you love, upload original content, and share it all with friends, family, and the world on YouTube. Dmv Test Youtube Manual California Writing Composition Youtubers Writing Process YouTube Enjoy the videos and music you love, upload original content, and share it all with friends, family, and the world on YouTube. Speed Limit California Helpful Hints Manual Youtube Useful Tips Handy Tips Youtubers YouTube Enjoy the videos and music you love, upload original content, and share it all with friends, family, and the world on YouTube.

Dmv Driving Test Second Child California Youtube Manual Youtubers YouTube Enjoy the videos and music you love, upload original content, and share it all with friends, family, and the world on YouTube. Sign Meaning Manual California Shit Happens Business Youtube Youtubers YouTube Enjoy the videos and music you love, upload original content, and share it all with friends, family, and the world on YouTube. Pinterest Explore Log in Sign up Privacy. The California DMV provides a wide variety of online drivers handbooks that will be useful for both the regular license holders the commercial driver license holders. Each manual is tailored to the specific audience and makes the job of finding the right information with no hassle. If you are just applying for your first California drivers license, then the regular California drivers handbook should be your choice. However, at some point you may find yourself looking for the information which is not contained in the regular

drivers license handbook and this is when other California DMV publications come in handy. At the moment, you can obtain the following California DMV drivers handbooks The book opens with a message from the California governor, Arnold Schwarzenegger, followed by the complete table of contents In addition to that, it also offers a few practice tests that can come in handy to those currently studying for the California permit test. The section describes the current California graduated drivers license law and how it affects you as a driver. Please remember that applicants who are younger than 17 and.The California drivers manual covers these procedures in the section for minors. The questions that will appear on your test are based on the information contained in the drivers handbook, so you will not need any other materials in order to be able to pass the exam. If you find that those sample tests are not enough, you can get more California practice permit tests online.

<https://www.northamericatalk.com/wp-content/plugins/formcraft/file-upload/server/content/files/1626f4f6c337f2--bosch-wfb-2005-manual-pdf.pdf>

Afterall, the book tells you exactly how you are supposed to drive and even has a separate section on safe driving practices. Make sure you revisit the book before you schedule your drivers license test. You can read the online drivers manual on the site or you can choose to download the drivers handbook PDF that can be later printed out. Our driver education classes are accepted by the California DMV. Designed for all California high school students in Sacramento, San Jose, Los Angeles, Long Beach, Oakland, Orange, San Diego, Riverside and all other areas of California. A service of Pacific High School.Written and vision tests are required when you apply for an original, renewal, or upgrade to a different class of license. Driving tests are usually waived for the class of license you currently have. Appointments are available for all DMV services. An appointment is usually required to take any driving test. There are exams in many different languages. However, you must have the ability to read traffic signs in English. If the exam is not available in the language you speak, you may take the exam with the help of an interpreter. The exams are also available in video, audio, and large print formats. If you have difficulty with an exam, tell the DMV employee. You can be more successful by following these suggestions Don't read anything extra into the question. There is only one correct answer.If you miss a question, the DMV employee can tell you where to find the correct answer.Sample questions are also available online. DMV's website [www.dmv.ca.gov](http://www.dmv.ca.gov).If you do not pass the vision test, you will be referred to your vision specialist. A driving test may be required. You may not use a bioptic telescopic or similar lens to meet this standard.This test is usually given by appointment only. For the driving test, bring with youMake sure your vehicle's brake lights, horn, parking brake, and electric signals are working properly and the vehicle does not have bald tires.

<http://bacvietexpress.com/upload/userfiles/files/boss-gt-5-instruction-manual.pdf>

The driver's side window must roll down. The windshield must allow a full unobstructed field of vision and there must be two rear view mirrors one must be on the left outside of the vehicle. You must demonstrate how to use the parking brake. You will be asked to show that your car is properly insured. If you use a rental car for the driving test, the driver's name must show on the contract as the insured. You must also wear your seat belt. Only you and the examiner or other DMV personnel can be in the vehicle. No animal may be in the vehicle. The examiner will give you directions and will not trick you or ask you to do anything illegal. The driving test will only be given after all the requirements have been met. However, during the test, you must use the vehicle's turn signal lights. When leaving the curb, do you use your mirrors and turn your head and look back for passing cars. Do you signal, and wait until it is safe before entering trafficDo you use the gas pedal, brake, steering wheel two hands on opposite sides, and other controls correctlyDo you use the proper lane. Do you signal, turn your head and look back before pulling away from the curb or when you change lanes. Do you signal the proper distance before turning. Do you follow other vehicles at a safe

distance Do you scan carefully for signs, signals, pedestrians, and other vehicles. Do you yield and take the right of way correctly Do you turn from the proper lane into the proper lane. Is your turn too wide or too sharp Can you stop quickly and safely in an emergency. In a vehicle with a manual transmission, do you keep the vehicle in gear or push the clutch in and coast to a stop Can you back in a straight line. Do you have complete control of the vehicle Do you stay a safe distance away from other vehicles when following or passing.

Do you stay a safe distance away from people walking or bicyclists riding on the road Are you courteous to other drivers and pedestrians If you pass the driving test, you will be issued an interim license valid for 60 days. Looking for a Traffic School Proof of insurance must be provided to the California DMV when you obtain your drivers license not your learners permit. The DMV's lousy handbook is partly to blame Much of it, he found, is written at a level requiring an advanced degree. Cecilia Hess He's been working recently with a senior who wants to improve her writing. The woman mentioned she'll have to renew her California driver's license next year, so they took a look together at the Department of Motor Vehicles handbook. "There were some paragraphs that she'd read, and she kind of understood what they were saying," Hess, 78, recalled the other day. "There were others where she'd look at me and say she had no idea what was happening." Intrigued, he decided to delve more deeply into the DMV handbook. The DMV admits there's a problem. To parse the language of the handbook, Hess employed what's known as the Flesch-Kincaid readability tests, which determine both accessibility of language and the grade level required for comprehension. You can try this yourself. Current versions of Microsoft Word are capable of running Flesch-Kincaid tests for reading ease and grade level. Go to the File menu, Options, Proofing. Click the box that says "show readability statistics." Respecting the right of way of others is not limited to situations such as yielding to pedestrians in crosswalks, or watching carefully to ensure the right of way of bicyclists and motorcyclists. Yield your right of way when it helps to prevent collisions." Hess observed that the concept of "right of way" isn't defined. The second sentence is needlessly long. The third sentence is ambiguous at best. The paragraph has a Flesch-Kincaid readability score of 38.

6 out of 100, which means it's "difficult to read" and requires a college level education for full comprehension. The higher the score, the better in terms of readability. You won't know the laws." Most analyses of the U.S. Constitution conclude an advanced degree is necessary to comprehend every word. A 2014 study found that Internal Revenue Service tax instructions are "very difficult" for people to understand. But if there's one official document you'd want to be accessible, it's the driver handbook. Hess wrote to the DMV with his concerns and offered some suggestions. Even when you have the right of way, don't assume that others will yield to you; be alert, and yield if necessary to avoid a collision." This suggests the agency has been more interested in accurately reflecting legislative and bureaucratic verbiage than in making the handbook accessible to ordinary drivers. The driver shall then yield the right of way to any vehicles which have approached from another highway, or which are approaching so closely as to constitute an immediate hazard, and shall continue to yield the right of way to those vehicles until he or she can proceed with reasonable safety." You can see the problem. If correlating with a linguistic stew like that is the goal, the DMV handbook succeeds wildly. If, on the other hand, the goal is to clearly communicate these concepts to ordinary people, the handbook is a spectacular failure. The DMV told me this won't happen before 2021 at the earliest. Here's my suggestion Do what Hess did and test drive handbook language with the Flesch-Kincaid tests. Then ask real people to sample what's been written before settling on a final draft. This is obviously more labor intensive and time consuming than simply mirroring what's in the vehicle code. The DMV should be making people better drivers, not worse. He also appears daily on KTLA Channel 5. His work runs in newspapers across the country and has resulted in a variety of laws protecting consumers.

This is why Don't believe them Don't believe them But experts say there solutions. Yes, he says, it's

really as bad as you've heard. Here are guides to help parents of schoolage children navigate remote learning, as well as recent updates about education in Southern California. But it's best to combine them. To help out new drivers, those studying for their license exams, and drivers who want to keep up to date with new or changing laws, the California Department of Motor Vehicles has published the California Driver Handbook. If you would like a printed copy of the California Drivers Handbook, there are copies available at your local DMV office. If you are not a native English speaker, you may download copies of the California Driver Handbook in Since laws are updated and changed nearly every year, the California Driver Handbook has a section just for updated and new driving laws in the state. You never know when that tome of information will be useful! Get a Quote. Its like having the answers before you take the test. DMV handbooks and drivers manuals include commercial drivers handbook, motorcycle handbook, CA vehicle code, and the CA drivers manual. For CA drivers looking for more detailed information about traffic laws and regulations, please visit CA DMV Vehicle Codes. Languages include English. Armenian. Spanish. Chinese. Korean. Vietnamese. Tagalog. Russian. Punjabi. Farsi. American Sign Language video The information in the DMV handbook will help you pass the written knowledge exam when you apply for a California drivers license. To obtain a hard copy of the drivers manual by mail, please contact your local CA DMV office or call 800 7770133 between 8 a.m. and 5 p.m. Driving manuals are also available in person at CA DMV offices. Whats in the Driver Handbook. The California DMV Handbook covers various topics, including Rules of the road. Learners permit requirements. Getting a drivers license in CA. Replacing a lost or stolen drivers license.

Vehicle insurance requirements. Changing your address. How to become an organ donor. Myths about seat belts. The drivers manual also includes tips on Driving in rain, fog, or snow. How to avoid road rage. Safety for the aging driver. Handling emergencies. Vehicle theft prevention. Reading through the DMV handbook is a great way to refresh your memory on the driving rules and regulations in California. Youll also find information in the drivers manual about the written and driving tests required for a CA drivers license. Dont Forget an Online Practice Test. A perfect complement to studying the CA DMV Manual is preparing for the written exam with the help of an online practice test. These industryleading study guides have been created to help you pass the test on your first attempt. Our certified partner offers practice tests for all types of licenses, including motorcycle and commercial vehicle licenses, that help you learn the information in the driving manuals. Motorcycle Handbook View the California Motorcycle Handbook DL 665 for information about motorcycle operation and licenses in CA. The DMV handbook covers information including Rules of the road for motorcyclists. Proper head, eye, feet, and face protection. Riding in a group. The motorcycle drivers manual also has some information about preparing for the written knowledge and driving exams. If you need general information about driving in California, such as road signs and defensive driving practices, see the CA drivers handbook in addition to the motorcycle driving manual. In addition to studying the motorcycle driving manual, you can take online practice tests to help you prepare for the written exam. Commercial Driver Handbook Before applying for a commercial drivers license CDL, you should take some time to study the California Commercial Driver Handbook DL 650, which is available online. The commercial drivers manual contains information about the following CDL written and road exams.

Medical requirements for commercial drivers. CDL disqualifications. Safety laws in California. The information in the commercial driving manual is the basis for the written test youll take when you apply for a CDL in California. Other CA DMV Handbooks Visit the California DMV website for other drivers manuals and DMV handbooks on topics such as Recreational vehicles and trailers. Parentteen training. Vehicle industry registration procedures in California. These DMV handbooks are designed to offer detailed guidance and information about the specific topics that they cover. California Vehicle Code The CA DMV website offers easy online access to the California Vehicle Code. The Vehicle Code offers more detail than the DMV manual. Youll find a range of information

related to all traffic laws, drivers licenses, and vehicle titles and registrations in California. Keep in mind that Vehicle Code is written in legal language and may be more difficult to understand than the information presented in the drivers handbook. Learn more about the contents of the Vehicle Code and why you may need it in addition to the California drivers manual. Get Your Study Guide. Whether you need a regular teen permit Driver License, Motorcycle License or Commercial License, this app is perfect for you. Everything you need is here in this app. You can download the OFFICIAL California driver handbook and be able to review it anytime, anywhere you want. You dont need any external app to review your downloaded books. Want to experience the real driver license knowledge test. You absolutely can, by trying out the included practice test with hundreds questions and real correct answers in English and Spanish combined. All rights reserved. If you require driving handbooks for other states, then please conduct a Google search for your state's handbook by searching for "StateName driving handbook". For example, search on Google for Michigan driving handbook pdf.

<http://schlammatlas.de/en/node/15927>